

THE AMAZINGLY VERSATILE AND INNOVATIVE LOADER

# **POWERFAB 300**

**SELF TRAILERING  
SKID STEER LOADER**

**TOWING MOBILITY  
SKID STEER ABILITY**

HYDROSTATIC TRANSMISSION/ENGINE POWERED

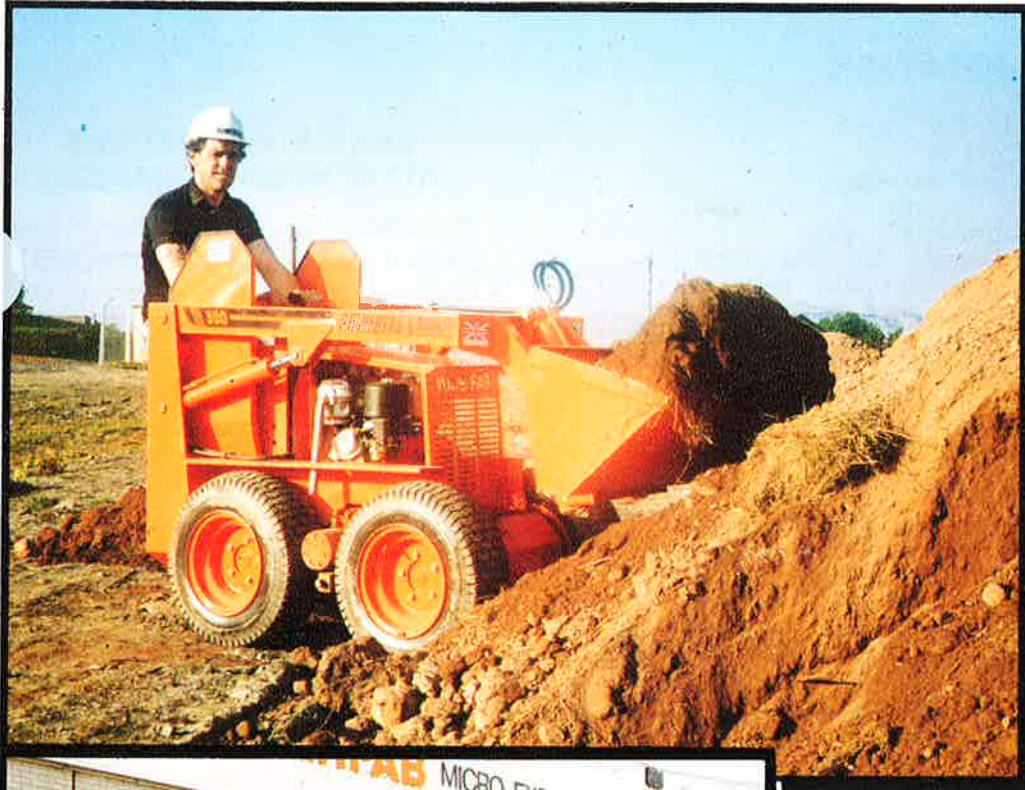

- LOW PURCHASE COST
- LOW MAINTENANCE
- BUILDS RENTAL PROFITS
- EASY "ONE-MAN" OPERATION
- QUICK RETURN ON INVESTMENT
- BUILDS REPEAT BUSINESS
- EASILY TOWED, CAR/LIGHT TRUCK

**DESIGNED FOR  
PERFORMANCE  
AND  
MANOEUVRABILITY**

- LOADS IN AREAS INACCESSIBLE TO BIGGER MACHINES •

SOLVES CONFINED LOADING, BACK FILLING AND BREAKER PROBLEMS OF NARROW WIDTHS, CONFINED AREAS, TIGHT ACCESS AND LOW OVERHEAD CLEARANCES

# POWERFAB 300

# Specification



Utility Fork



Landscape Rake



Grapple



Angle Broom



Breaker



Tine Bucket



Trencher

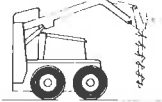

Post Hole Borer

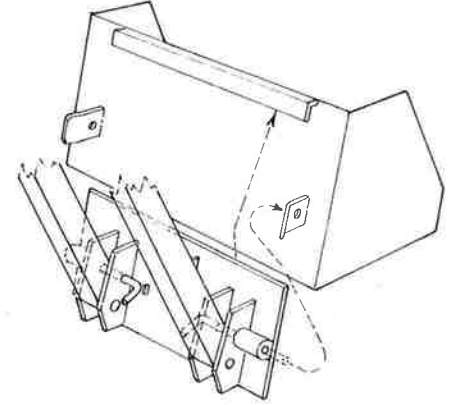

## TECHNICAL INFORMATION

**WEIGHT OF MACHINE:** 740 Kg.

**RATED CAPACITY:** 225Kg MAX

**MAX SPEED:** 3.44 KPH on 23" dia. wheels

**BUCKET CAPACITY:** In accordance with SAE standard No J818A

**ENGINE (STANDARD):** Honda GX 340 11HP overhead valve, Air cooled petrol engine with recoil start.  
Electric start optional extra.

**ENGINE (OPTIONAL):** Yanmar Air Cooled Diesel 9HP  
Mitsubishi Disel Water Cooled 15HP

**STANDARD TYRE:** 6 x 12 x 4ply (23" dia.approx). Where other tyres are required contact Powerfab Design Dept.

**OPERATION (DRIVE):** Steering and drive, forward and reverse, controlled by two levers. Indirect Hydrostatic Drive to wheels with 3 : 1 mechanical reduction resulting in reduced maintenance costs.

## SPECIAL FEATURES

(OPTIONAL EXTRAS)

**HYDRAULIC P.T.O.** Capacity 138 Bar (2000psi) max. Flow 28 LPM (6.2 GPM) max at engine speed of 3600 rpm. Complete with Quick Release Couplings for hand held Breaker, Water pump etc. Air Turbo Cooled Hydraulic System.

**TACHOMETER**  
**PARALLEL LINKAGE**  
**FLOATATION TYRES**  
**LIGHTS**  
**TRACKS**

## FASTER AND SECURE ATTACHMENT CHANGES

Powerfab Loader arm fixing plate slides into attachment flange and is quickly wedged into position with quick fit/release levers.

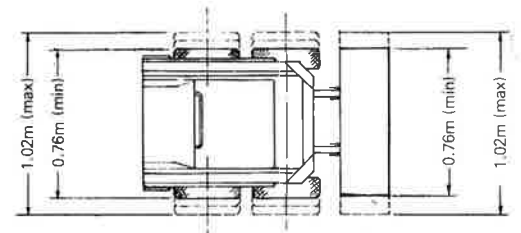
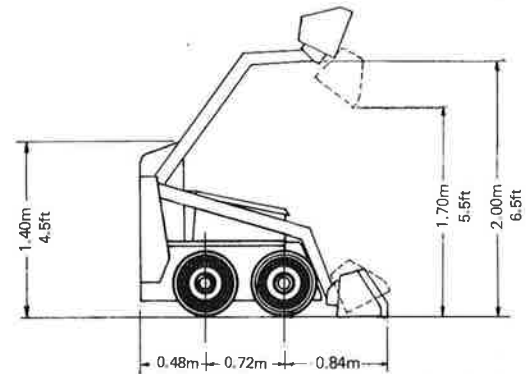

Due to Company Policy of continual improvement we reserve the right to change the design or specification at any time without notice. For exact information about any modification contact manufacturer or dealer.

Your Powerfab Distributor.

# POWERFAB

SALES & SPARES LIMITED

FAIR VIEW, ASHVALE,

TREDEGAR, GWENT NP2 3HA

UNITED KINGDOM.

TELEPHONE: 049525 - 6627.

TELEX: 498973 POWFAB G.









FAX: 0495 - 718162

# POWERFAB 300

## SELF TRAILERING SKID STEER LOADER

### PRICE LIST

OPTIONAL EXTRAS

- 21)  HYDRAULIC EARTH DRILL (WITH ATTACHING BRACKET)  
USED WITH SINGLE HPTO ..... £936.00
  - 22) AUGERS TO SUIT
  - 23) 6" DIAMETER ..... £290.00
  - 24) 12" DIAMETER ..... £368.00
  - 14" DIAMETER ..... £414.00
  - 25)  HYDRAULIC ANGLE DOZER BLADE (USED WITH HPTO) ..... £540.00
  - 26) MECHANICAL ANGLE DOZER BLADE ..... £390.00
  - 27)  PALLET FORKS ..... £230.00
  - 28)  LANDSCAPES RAKE ..... £160.00
  - 29)  ROTARY BRUSH (MECHANICAL ANGLE USED WITH SINGLE HPTO) £1650.00
  - 30)  ROTARY BRUSH (HYDRAULIC ANGLE USED WITH DOUBLE HPTO  
AND FLOW DIVIDER) ..... £1840.00
  - 31)  TWIN TINE RIPPER ..... £160.00
  - 32)  TACHOMETER (MECHANICAL). PRICE ON APPLICATION.
  - 33)  CANOPY. PRICE ON APPLICATION.
- HYDRAULIC POWER UNIT. HONDA 11HP GX340 PETROL ENGINE  
(ROPE START). ALSO AVAILABLE ROBIN DIESEL ENGINE. £1400.00
- .....
- BROCHURE NO: P0055

POWERFAB SALES & SPARES LTD  
FAIR VIEW, ASHVALE, TREDGAR,  
GWENT. NP2 3HA.

TELEPHONE: 0495256627/8

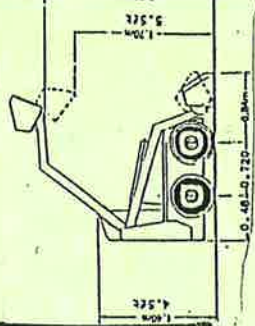
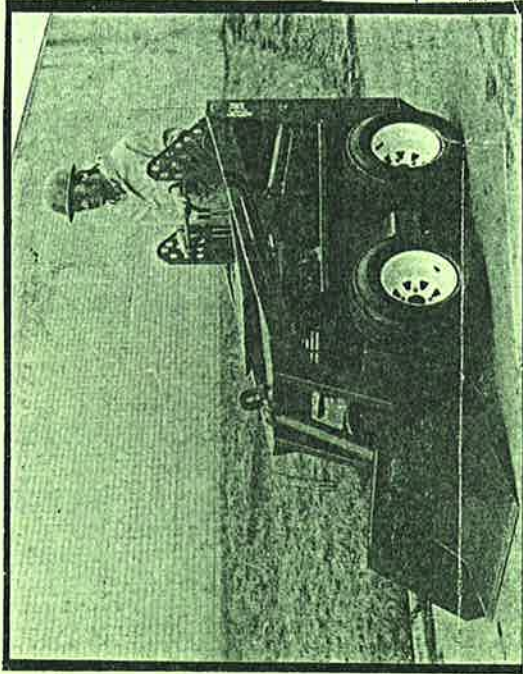

BASIC SPECIFICATION

WEIGHT OF MACHINE 740 KG.  
 RATED CAPACITY 225 KG MAX. (495 LB).  
 MAX. SPEED 4.6 KPH ON 23 DIA. WHEELS.  
 DRAW BAR PULL .720 TONNES.  
 BRIGGS & STRATTON VANGUARD SERIES. 11.2 KW (15 HP) PETROL ENGINE,  
 TWIN CYLINDER OVER HEAD VALVE, AIR COOLED ENGINE,  
 (ELECTRIC START). SINGLE PUMP ONLY (10.6 cc).  
 SINGLE LEVER CONTROL.  
 SINGLE HYDRAULIC POWER TAKE OFF.  
 SEAT.

VARIOUS BUILDS AVAILABLE

- A) 30" MACHINE (30" BUCKET PLUS TRACTIVE PATTERN TYPES T63) £5840.00
- B) 40" MACHINE (40" BUCKET PLUS TRACTIVE PATTERN TYRES T463) £5990.00
- C) 40" MACHINE (40" BUCKET PLUS GRASS PATTERN TYPES HP224) £6030.00
- D) 40" MACHINE (40" BUCKET PLUS ROCK PATTERN TYPES DL) £6160.00

OPTIONAL EXTRAS

1) DOUBLE POWER TAKE OFF (FACTORY FITTED).  
HYDRAULIC POWER TAKE OFF, QUICK RELEASE COUPLINGS  
POSITIONED AT BUCKET END. BRIGGS & STRATTON 38 LPM  
8.46 GPM. .... £430.00

2) FLOW CONTROL.  
HYDRAULIC POWER TAKE OFF FOR SWEEPER. (FACTORY FITTED)  
IN ADDITION TO (A). INCLUDES PREFERENTIAL PRESSURE  
COMPENSATION FLOW DIVIDER WITH HAND KNOB ROTATION FOR  
INFINITE VARIATION OF FLOW TO HYDRAULIC POWER TAKE OFF  
AND DRIVE. .... £ 96.00

3) DIGGING ARM ATTACHMENT WITH DIGGING DEPTH 4'8" AND TEAR  
OUT FORCE AT BUCKET TOOTH 1 TONNE COMPLETE WITH 13"  
BUCKET (USED WITH SINGLE HYDRAULIC POWER TAKE OFF). .... £660.00

4) DIGGING ARM ATTACHMENT 105 DEGREE SWING. DIGGING DEPTH  
4'8" AND TEAR OUT FORCE AT BUCKET TOOTH 1 TONNE COMPLETE  
WITH 13" BUCKET. (USED WITH DOUBLE H.P.T.O. FACTORY FITTED) .... £990.00

DIESEL ENGINES: (ADDITIONAL PRICE FOR ALTERNATIVE ENGINE  
BELOW TO STANDARD)

OPTIONAL EXTRAS



7) POWERFAB MACHINE HELD BREAKER COMPLETE WITH POINT £3080.00



8) 3' TRENCHER HARD DIG (SINGLE HPTO) ... £2720.00  
9) 3' TRENCHER SOFT DIG (SINGLE HPTO) ... £1998.00



10) BUCKETS - 30" WIDE (.086M 3.03 FT) ... £154.00  
11) 40" WIDE (.115M 4.05 FT) ... £175.00



12) MANURE FORK (30") ... £242.00  
13) MANURE FORK (42") ... £308.00



14) FORK GRAPPLE - 30" (USED WITH SINGLE HPTO) ... £385.00  
15) 40" (USED WITH SINGLE HPTO) ... £440.00

16) HYDRAULIC TURBO COOLING UNIT RECOMMENDED WITH  
HAND HELD BREAKERS (ALSO HOT CLIMATES) ... £264.00

EXPORT CRATE PRICE £120.00

WHEELS  
17) 650 X 10 (DL) - ROCK PATTERN ... £484.  
18) 23 X 8.5 X 12 4 PLY - T463 PATTERN ... £435.  
19) 23 X 8.5 X 12 4 PLY - HP224 PATTERN ... £385.  
20) 6 X 12 X 4 PLY - T63 PATTERN ... £260.

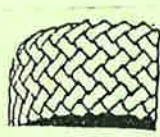
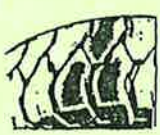

Rock Pattern Pressure: Grass Pattern Pressure: Traction Pattern Pressure: T463 - 22 PSI